

# Prefaest

## Maatvoering SF • Kabelgoten



### Gootkenmerken

- ~ C35/45 (EN 206) betonkwaliteit
- ~ Tweezijdig vaar- en moereind
- ~ Ingebouwde hijslussen
- ~ Paspennen en gaten (niet voor maten groter dan SF 62-65)
- ~ Begin- en eindplaten
- ~ Hoek- en passtukken op aanvraag

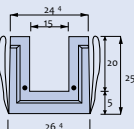
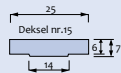

SF 15-20

	SF 15 -20	Deksel nr.15
Lengte (cm)	225	75
Gewicht (kg)	85	29
Sectie (cm <sup>2</sup> )	270	-
Max. Belasting (ton)	-	25

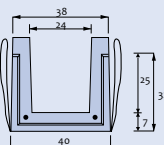
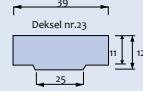
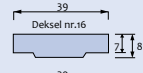

SF 24-25

	SF 24 -25	Deksel nr.16	Deksel nr.23
Lengte (cm)	225	75	75
Gewicht (kg)	166	51	80
Sectie (cm <sup>2</sup> )	578	-	-
Max. Belasting (ton)	-	25	40

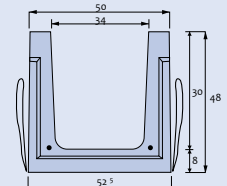
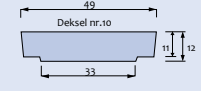
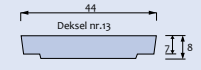

SF 34-30

	SF 34 -30	Deksel nr.13	Deksel nr.10
Lengte (cm)	225	75	75
Gewicht (kg)	189	66	98
Sectie (cm <sup>2</sup> )	994	-	-
Max. Belasting (ton)	-	25	40

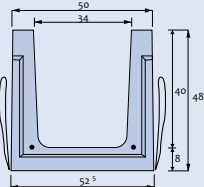
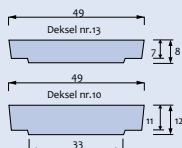

SF 34-40

	SF 34 -40	Deksel nr.13	Deksel nr.10
Lengte (cm)	225	75	75
Gewicht (kg)	286	66	98
Sectie (cm <sup>2</sup> )	1284	-	-
Max. Belasting (ton)	-	25	40

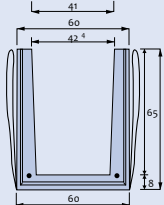
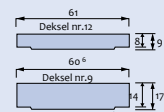

SF 42-65

	SF 42 -65	Deksel nr.12	Deksel nr.9
Lengte (cm)	300	75	75
Gewicht (kg)	409	94	180
Sectie (cm <sup>2</sup> )	2645	-	-
Max. Belasting (ton)	-	25	40

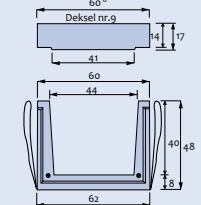
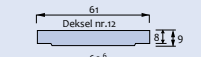

SF 44-40

	SF 44 -40	Deksel nr.12	Deksel nr.9
Lengte (cm)	225	75	75
Gewicht (kg)	289	94	180
Sectie (cm <sup>2</sup> )	1124	-	-
Max. Belasting (ton)	-	25	40

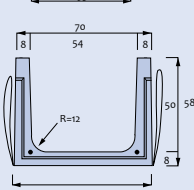
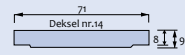

SF 54-50

	SF 54 -50	Deksel nr.14	Deksel nr.11
Lengte (cm)	225	75	75
Gewicht (kg)	378	105	196
Sectie (cm <sup>2</sup> )	2597	-	-
Max. Belasting (ton)	-	25	40

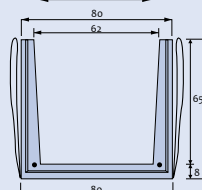
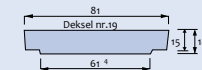
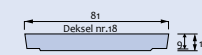

SF 62-65

	SF 62 -65	Deksel nr.18	Deksel nr.19
Lengte (cm)	300	75	75
Gewicht (kg)	440	139,5	239
Sectie (cm <sup>2</sup> )	3945	-	-
Max. Belasting (ton)	-	25	40



# Prefaest

## Maatvoering SF • Kabelgoten

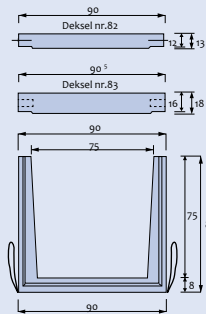

SF 75-75

	Deksel nr.82	Deksel nr.83
Lengte (cm)	240	80
Gewicht (kg)	484	250
Sectie (cm <sup>2</sup> )	5512	-
Max. Belasting (ton)	25	40

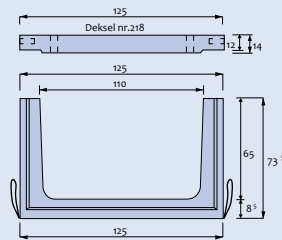

SF 110-65

	Deksel nr.218
Lengte (cm)	243
Gewicht (kg)	529
Sectie (cm <sup>2</sup> )	7081
Max. Belasting (ton)	40

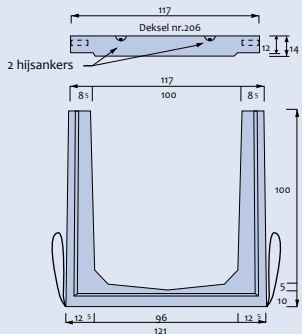

SF 100-100

	Deksel nr.206	Deksel nr.206
Lengte (cm)	220	110
Gewicht (kg)	924	442
Sectie (cm <sup>2</sup> )	9870	-
Max. Belasting (ton)	25	40

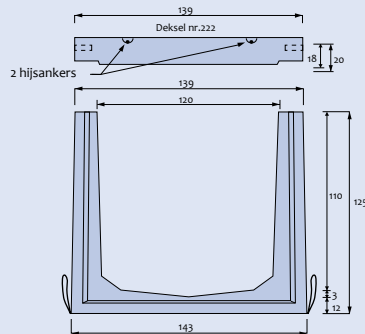

SF 120-110

	Deksel nr.222	Deksel nr.222
Lengte (cm)	220	110
Gewicht (kg)	1112	726
Sectie (cm <sup>2</sup> )	12973	-
Max. Belasting (ton)	25	40

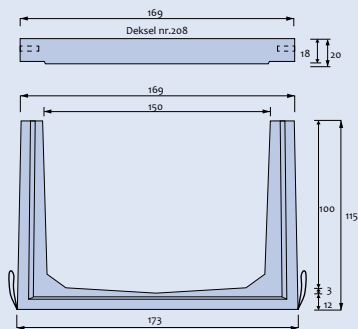

SF 150-100

	Deksel nr.208	Deksel nr.208
Lengte (cm)	220	1105
Gewicht (kg)	1151	868
Sectie (cm <sup>2</sup> )	14869	-
Max. Belasting (ton)	25	40



# INFRATEQ

wapening > verkeer > afwatering

Intercodam Infra BV

De Huchtstraat 43

1327 EC Almere

telefoon 036 535 9250

fax 036 535 9259

e-mail [info@intercodaminfra.com](mailto:info@intercodaminfra.com)

[www.intercodaminfra.com](http://www.intercodaminfra.com)

Our Total Quality Management System is certified according to NEN-EN-ISO 9001 : 2008